

Lumensense«

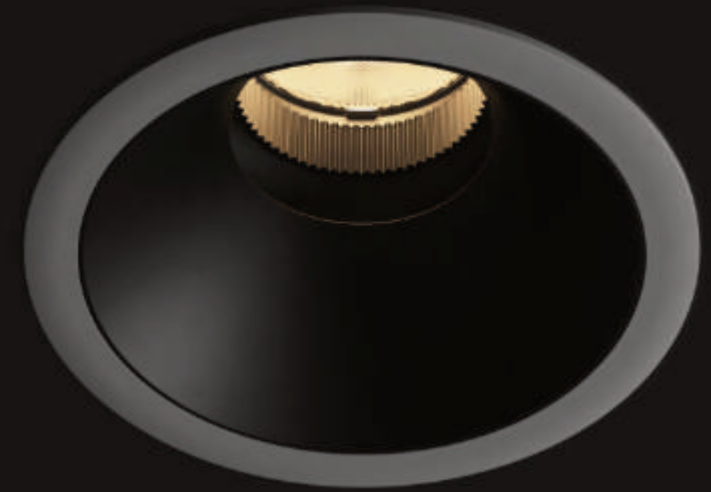

2025 New Product Collection

BOUNDLESS

Derived from a design concept of no borders and unlimited space. Its miniaturized design allows it to be concealed in the ceiling, requiring only a small opening of 55 to 65 millimeters, effectively maintaining the overall aesthetic of the space. Whether in hotel lobbies, home spaces, or dining venues, it provides flexible and efficient lighting solutions to meet the needs of different spaces.



Modular Designs

Trimless



Trim



Trim/Trimless options are available for installation and maintenance, reducing the risk of ceiling damage.

9-12W

Φ 55-65mm





18W

Φ75mm

Product Details

Cooling System

German technology spraying surface treatment radiator, delicate touch, effectively dissipate the heat of the light source, to ensure reasonable thermal performance and long service life of the lamp body.



Anti-Light Leakage

By ensuring focused illumination in the required areas, it enhances light efficiency and lighting quality, while avoiding glare and unnecessary energy wastage.



Shrapnel

Made of imported manganese steel, the stainless steel spring clip features excellent elasticity and durability, and is highly resistant to deformation.



Light Color Contrast

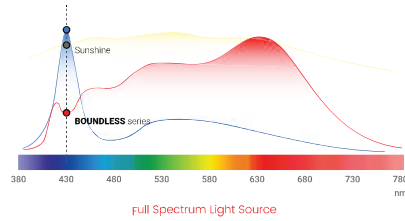

Downlights designed specifically for hotel home decor, featuring excellent color temperature consistency (low color variance), with light hues closely resembling natural sunlight, offering full-spectrum lighting effects.

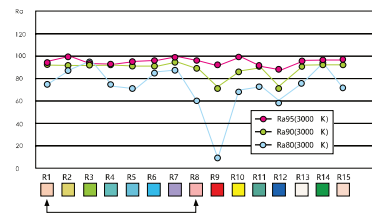

Designed specifically for catering clubs, the downlights feature a bespoke full spectrum with a high R9 value that enhances the vibrancy of the colours in your food, resulting in more appetite stimulation.

CRI > 97

Utilizes high-performance, high color rendering index chips, with an average CRI > 97 at color temperatures of 2700K/3000K/3500K/4000K.



External Designs

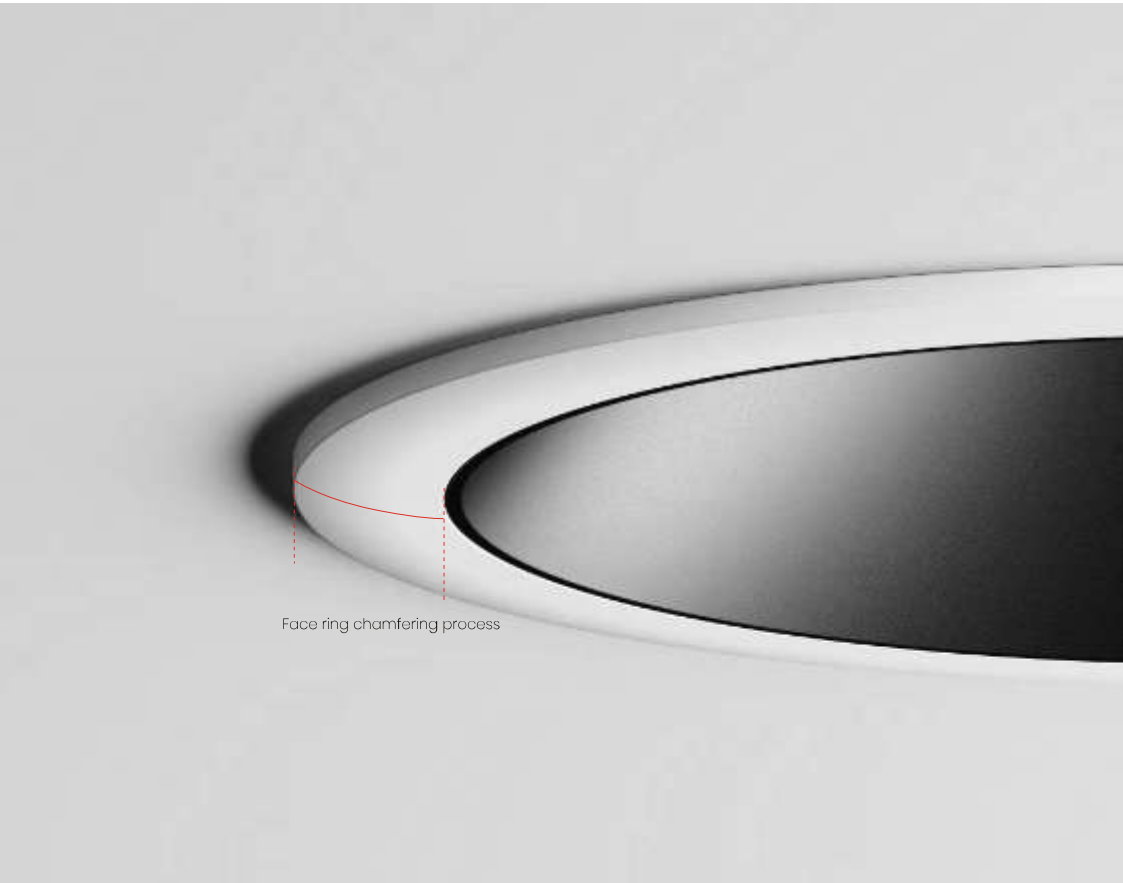

Face ring chamfering process

Ring Around The Face

The face ring is crafted with just the right amount of curvature to match the ceiling perfectly.

The elegant white anti-glare cover is for the consistency of the ceiling when the lights are switched off.



Pearl black, elegant black is the pursuit of anti-glare comfortable environment after turning on the light.



Anti-Glare Shield

Curved extremely narrow edge anti-glare cover, more accurate light control, more beautiful appearance.

Adjustment

With highly flexible 30° angle adjustment function, it brings dynamic and changeable light and shadow effects to your space.

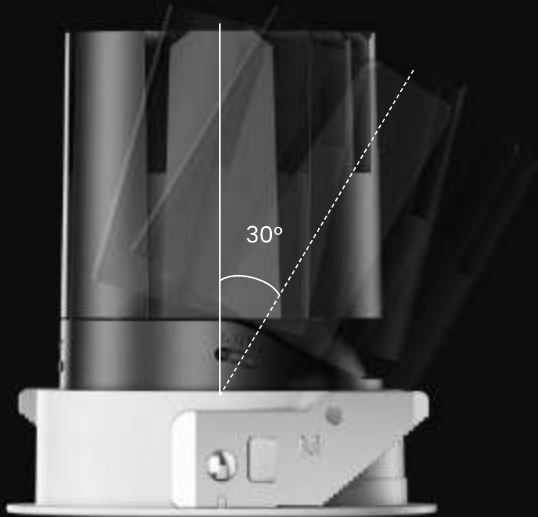

Precision gear scale design ensures that the module can be rotated smoothly through 360°, providing a full range of flexible adjustments.

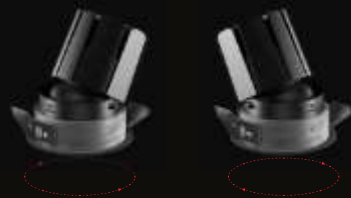

Optional Optics

Direct lighting

Designed for focused downlighting, it provides a uniform transition of light spots, achieving precise and elegant light control, creating a lighting effect that is both focused and harmonious.



Oblique lighting

Designed for oblique wall-washing illumination, it provides soft and uniform lighting with no secondary glare, enhancing the visual appeal of walls and adding a sense of warmth to the space.

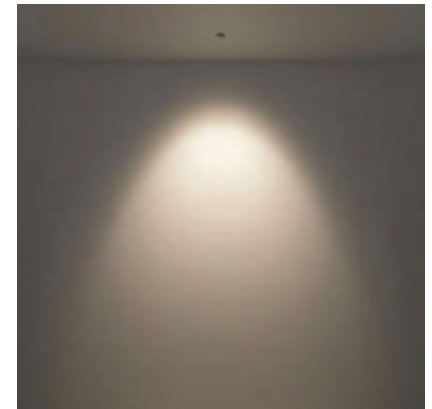

Waterproof
IP65



Multiple Light Effects

15°, 24°, 36°, 50°, 70° precise light control design, pure light colour, perfect light spot, suitable for a variety of key lighting applications space requirements.

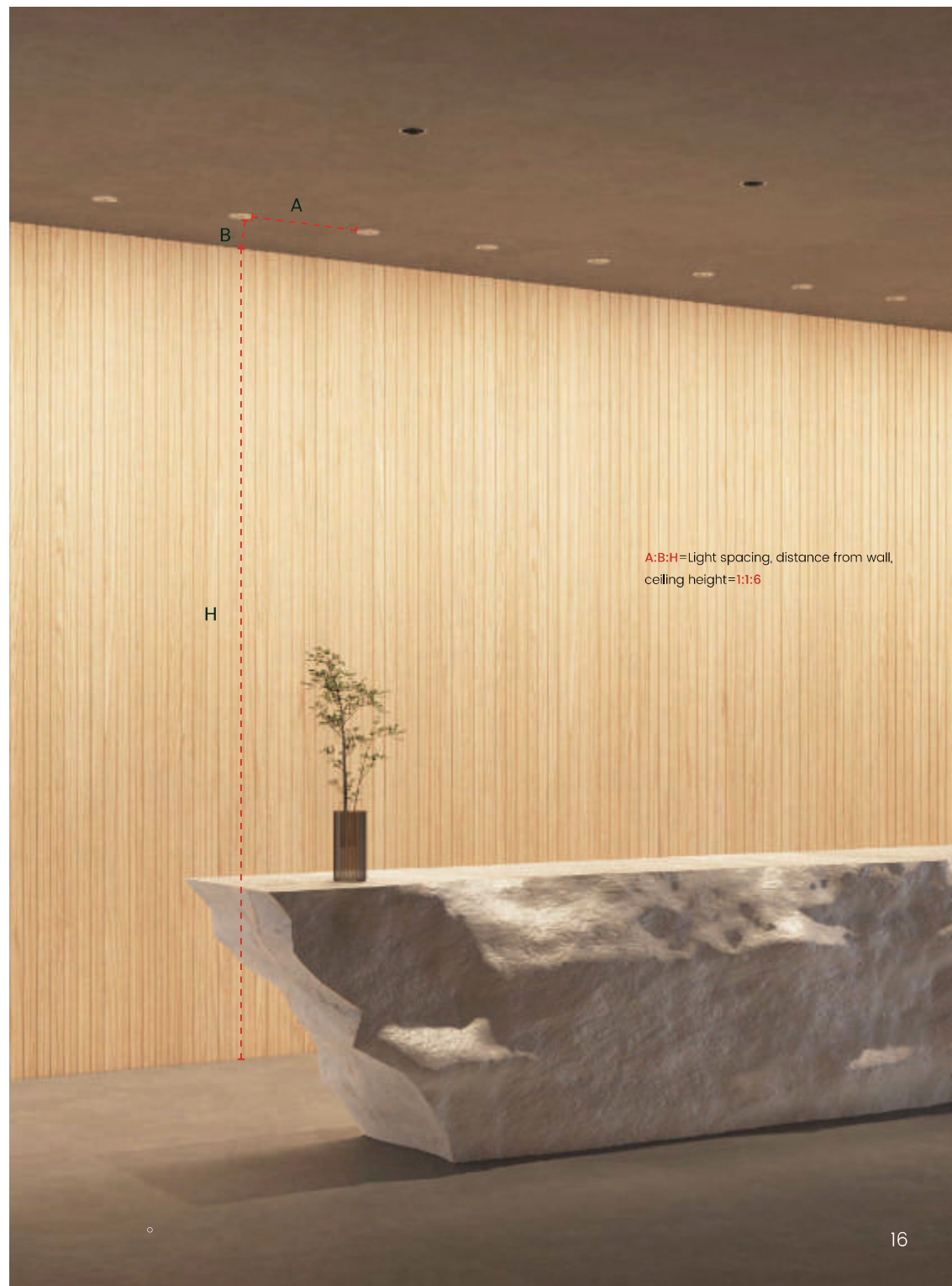
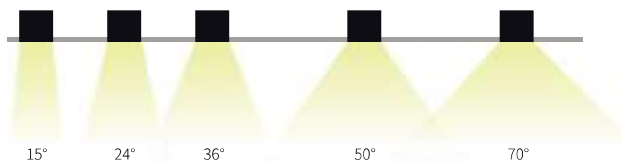

A:B:H=Light spacing, distance from wall,
ceiling height=1:1:6



Model	Power	Beam Angle	CRI	CCT	Cut-out(mm)	Size(mm)
BM-WJ1055	5W/8W	15°/24°/36°/50°	>97	2700K/3000K/3500K/4000K	φ55	φ61x82
BM-WJ1065	8W/10W	15°/24°/36°/50°	>97	2700K/3000K/3500K/4000K	φ65	φ72x86
BM-WJ1075	10W/12W	15°/24°/36°/50°	>97	2700K/3000K/3500K/4000K	φ75	φ83x93
BM-WJ1075G	15W/18W	15°/24°/36°/50°	>97	2700K/3000K/3500K/4000K	φ75	φ83x108
BM-WJ1095	20W/24W	15°/24°/36°/50°	>97	2700K/3000K/3500K/4000K	φ95	φ104x118



Model	Power	Beam Angle	CRI	CCT	Cut-out(mm)	Size(mm)
BM-WJ1055W	5W/8W	15°/24°/36°/50°	>97	2700K/3000K/3500K/4000K	φ55	φ85x82
BM-WJ1065W	8W/10W	15°/24°/36°/50°	>97	2700K/3000K/3500K/4000K	φ65	φ98x86
BM-WJ1075W	10W/12W	15°/24°/36°/50°	>97	2700K/3000K/3500K/4000K	φ75	φ110x93
BM-WJ1075GW	15W/18W	15°/24°/36°/50°	>97	2700K/3000K/3500K/4000K	φ75	φ110x108
BM-WJ1095W	20W/24W	15°/24°/36°/50°	>97	2700K/3000K/3500K/4000K	φ95	φ135x118

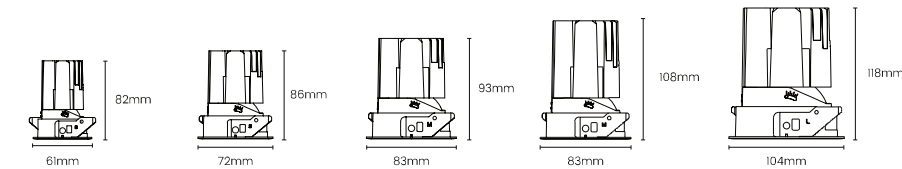

BM-WJ1055 BM-WJ1065 BM-WJ1075 BM-WJ1075G BM-WJ1095

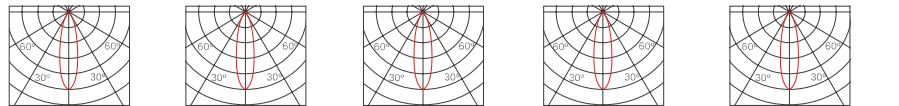

Model	Beam Angle	H(m)	L(m)	W(m)	E(max)
BM-WJ1055	24°	1	0.38	0.38	1291
		2	0.76	0.76	355
		3	1.13	1.13	158
		4	1.51	1.51	89
BM-WJ1065	24°	1	0.4	0.4	2182
		2	0.8	0.8	546
		3	1.2	1.2	242
		4	1.6	1.6	136
BM-WJ1075	24°	1	0.41	0.41	2307
		2	0.82	0.82	577
		3	1.24	1.24	256
		4	1.65	1.65	144
BM-WJ1075G	24°	1	0.47	0.47	4263
		2	0.88	0.88	1065
		3	1.32	1.32	474
		4	1.75	1.75	267
BM-WJ1095	24°	1	0.53	0.53	5684
		2	1.0	1.0	1420
		3	1.42	1.42	632
		4	1.85	1.85	356

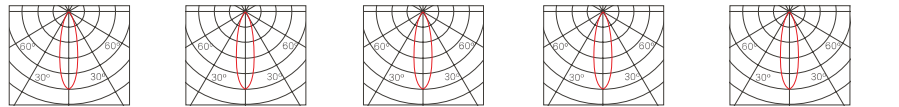

Model	Beam Angle	H(m)	L(m)	W(m)	E(max)
BM-WJ1055W	24°	1	0.38	0.38	1421
		2	0.76	0.76	355
		3	1.13	1.13	158
		4	1.51	1.51	89
BM-WJ1065W	24°	1	0.4	0.4	2182
		2	0.8	0.8	546
		3	1.2	1.2	242
		4	1.6	1.6	136
BM-WJ1075W	24°	1	0.41	0.41	2307
		2	0.82	0.82	577
		3	1.24	1.24	256
		4	1.65	1.65	144
BM-WJ1075GW	24°	1	0.47	0.47	4263
		2	0.88	0.88	1065
		3	1.32	1.32	474
		4	1.75	1.75	267
BM-WJ1095W	24°	1	0.53	0.53	5684
		2	1.0	1.0	1420
		3	1.42	1.42	632
		4	1.85	1.85	356

Optional Accessories



Honeycomb Combed Glass Soft Glass

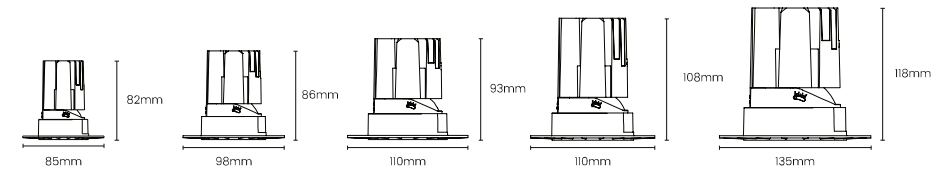

BM-WJ1055W BM-WJ1065W BM-WJ1075W BM-WJ1075GW BM-WJ1095W

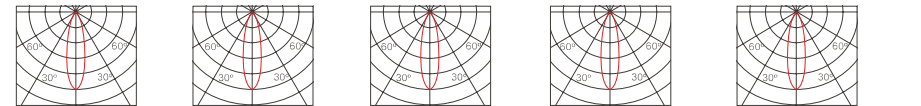

Model	Beam Angle	H(m)	L(m)	W(m)	E(max)
BM-WJ1055W	24°	1	0.38	0.38	1421
		2	0.76	0.76	355
		3	1.13	1.13	158
		4	1.51	1.51	89
BM-WJ1065W	24°	1	0.4	0.4	2182
		2	0.8	0.8	546
		3	1.2	1.2	242
		4	1.6	1.6	136
BM-WJ1075W	24°	1	0.41	0.41	2307
		2	0.82	0.82	577
		3	1.24	1.24	256
		4	1.65	1.65	144
BM-WJ1075GW	24°	1	0.47	0.47	4263
		2	0.88	0.88	1065
		3	1.32	1.32	474
		4	1.75	1.75	267
BM-WJ1095W	24°	1	0.53	0.53	5684
		2	1.0	1.0	1420
		3	1.42	1.42	632
		4	1.85	1.85	356

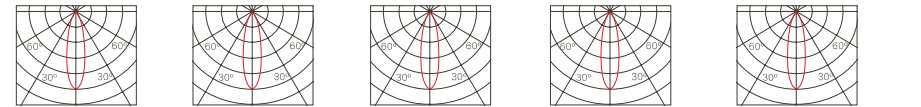

Model	Beam Angle	H(m)	L(m)	W(m)	E(max)
BM-WJ1055W	24°	1	0.4	0.4	2182
		2	0.8	0.8	546
		3	1.2	1.2	242
		4	1.6	1.6	136
BM-WJ1065W	24°	1	0.41	0.41	2307
		2	0.82	0.82	577
		3	1.24	1.24	256
		4	1.65	1.65	144
BM-WJ1075W	24°	1	0.43	0.43	2432
		2	0.84	0.84	608
		3	1.28	1.28	270
		4	1.7	1.7	152
BM-WJ1075GW	24°	1	0.51	0.51	4973.5
		2	0.92	0.92	1242.5
		3	1.38	1.38	553
		4	1.8	1.8	311.5
BM-WJ1095W	24°	1	0.57	0.57	10912
		2	1.4	1.4	2728
		3	1.48	1.48	1212
		4	1.95	1.95	682

Optional Accessories



Honeycomb Combed Glass Soft Glass

Product Information

BOUNDLESS



Model	Power	Beam Angle	CRI	CCT	Cut-out(mm)	Size(mm)
BM-WJ1075T	10W/12W/15W	15°/24°/36°/50°	>97	2700K/3000K/3500K/4000K	Φ75	Φ83x58
BM-WJ1075X	10W/12W/15W	/	>97	2700K/3000K/3500K/4000K	Φ75	Φ83x58

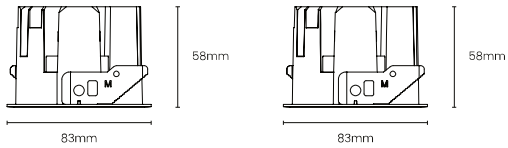

BM-WJ1075T

BM-WJ1075X

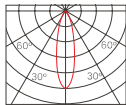

10W 24°

H(m)	L(m)	W(m)	E(max)
1	0.35	0.35	75.2
2	0.7	0.7	18.8
3	1.05	1.05	12.8
4	0.7	0.7	4.8

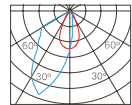

10W

H(m)	L(m)	W(m)	E(max)
1	0.46	0.46	33.8
2	1.02	1.02	84.6
3	1.52	1.52	37.3
4	2.1	2.1	21.3

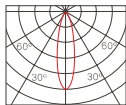

15W 24°

H(m)	L(m)	W(m)	E(max)
1	0.7	0.7	150.4
2	1.4	1.4	37.6
3	2.1	2.1	32.8
4	2.8	2.8	9.6

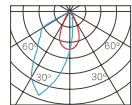

12W

H(m)	L(m)	W(m)	E(max)
1	0.76	0.76	50.9
2	1.53	1.53	12.7
3	2.29	2.29	5.6
4	3.05	3.05	3.2

Optional Accessories



Honeycomb

Combed Glass

Soft Glass

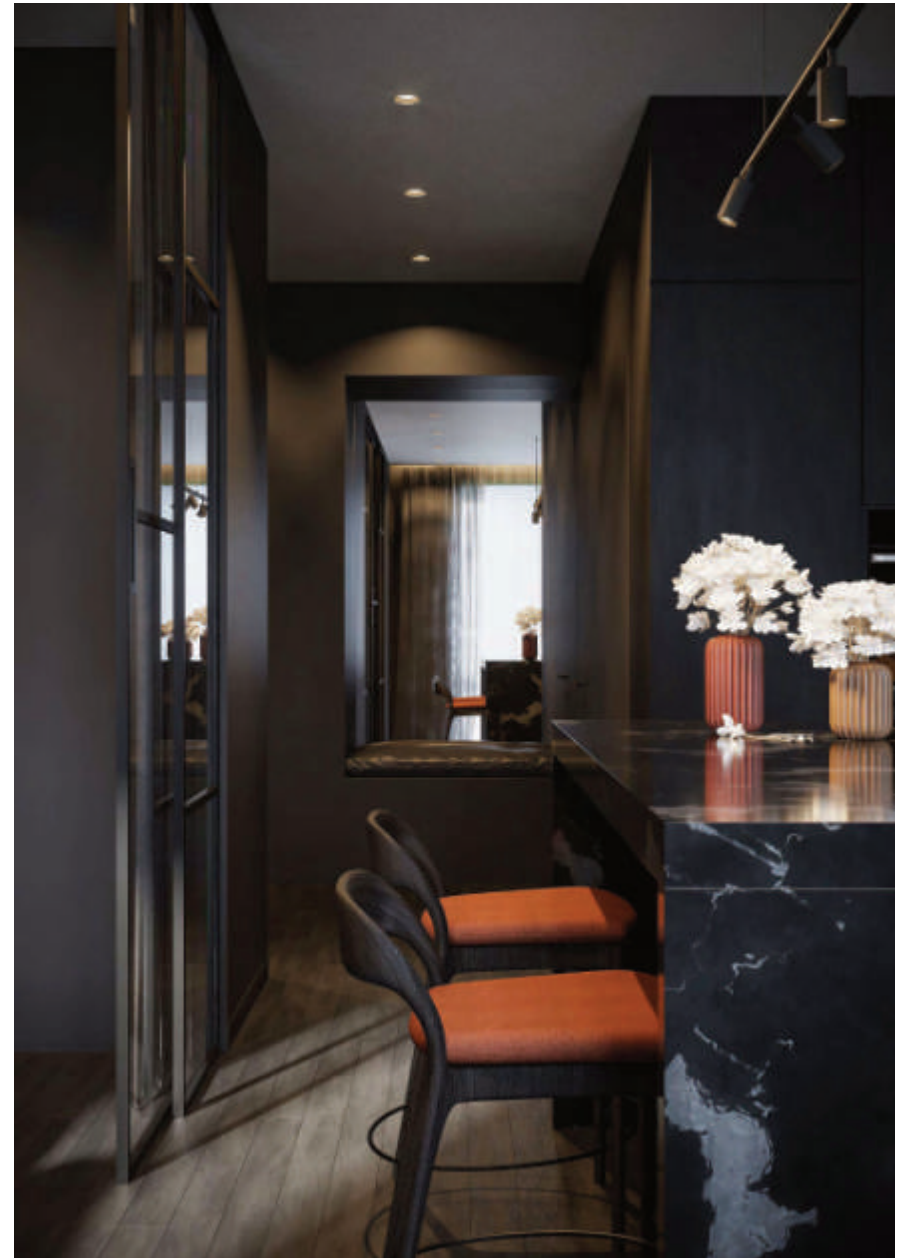

STARS

The Starry Sky series is a product specially designed for hotels, with a simple, elegant and high-end appearance. It has three types of light output: large circle light output, small circle light output, and elliptical light output, and can adapt to 95% of ceiling depth installation to meet the needs of different spaces.



Multiple Anti Glare Covers



Two styles: trim and trimless
Four colors: matte white, matte black, pearl black, bright silver
Three ways of emitting light: large circle emitting light, small circle emitting light, ellipse emitting light



Modular Designs

Face ring die-casting integrated molding, no splicing
The surface ring craftsmanship with just the right curvature perfectly matches the ceiling

Quick Installation

The height of the lamp body is 7.9cm, which meets 95% of the installation depth of the ceiling. The spring clip structure is easy to install and suitable for ultra-thin and ultra thick ceilings.

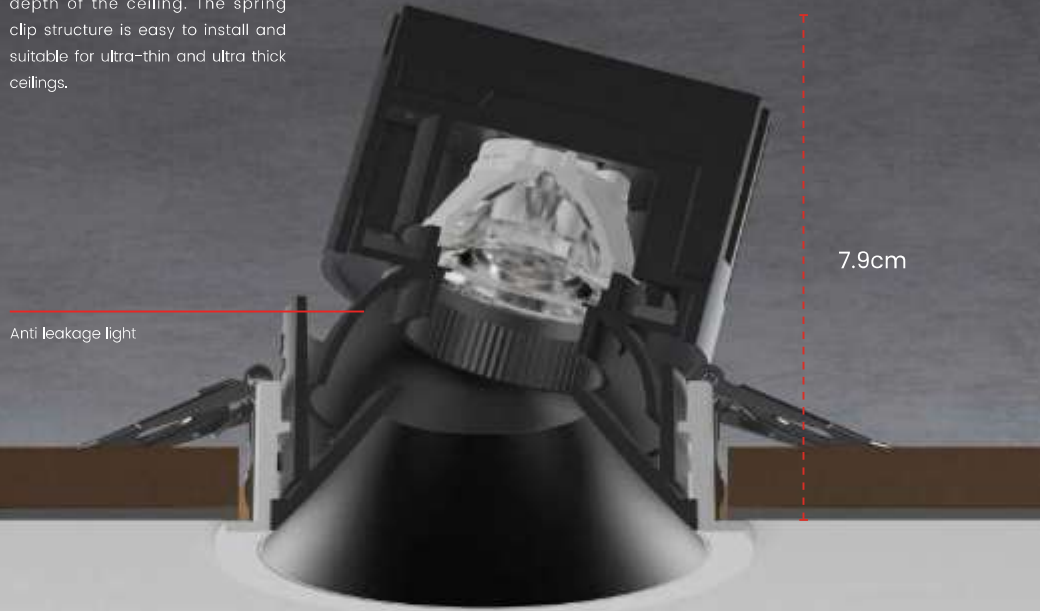

Integrated Surface Ring

Small circular and elliptical light-emitting surface rings are the preferred choices for star rated hotels.



Adjustment



Horizontal Rotation

Precision gear scale design ensures that the module can be rotated smoothly through 360°, providing a full range of flexible adjustments.



Vertically Adjustable

30° free adjustment, adjustable angle, bringing more light and shadow changes to the space, humanized design, creating your own lighting effect.

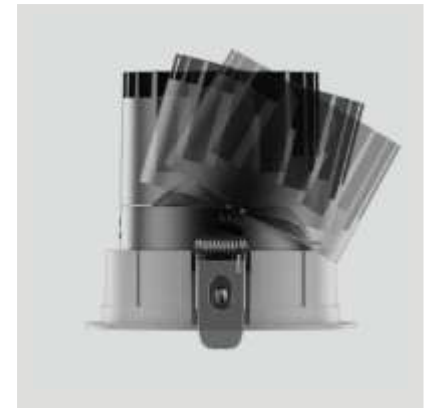

Customized

Specially designed for hotel home decoration, the tube lamp can be customized with colorful RGBCW light source, with RGB free transformation and 1000K-20000K color temperature to choose from.



Product Information



Model	Power	Beam Angle	CRI	CCT	Cut-out(mm)	Size(mm)
BM-XCI075	9W/12W	15°/24°/36°/50°	>90	2700K/3000K/3500K/4000K	Φ75	Φ83x79
BM-XCI075W	9W/12W	15°/24°/36°/50°	>90	2700K/3000K/3500K/4000K	Φ75	Φ110x79
BM-XCI075S	9W/12W	15°/24°	>90	2700K/3000K/3500K/4000K	Φ75	Φ83x79
BM-XCI075E	9W/12W	15°/24°	>90	2700K/3000K/3500K/4000K	Φ75	Φ83x79

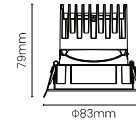

BM-XCI075
BM-XCI075S
BM-XCI075E

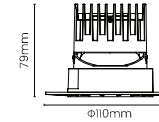

BM-XCI075W

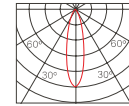

9W 24°

H(m)	L(m)	W(m)	E(max)
1	0.38	0.38	2242
2	0.75	0.75	560
3	1.13	1.13	245
4	1.51	1.51	140

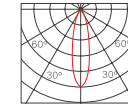

12W 24°

H(m)	L(m)	W(m)	E(max)
1	0.5	0.5	2799
2	1.00	1.00	700
3	1.50	1.50	311
4	2.00	2.00	175

Optional Accessories



Honeycomb Combed Glass Soft Glass

CONCEAL

The precision of optical technology has been enhanced, along with meticulous refinement in the product's appearance design. This pursuit of perfection in details ensures that users enjoy a more comfortable and superior lighting environment.





Space Lighting

Mini lamp body shape, using high-quality die-casting aluminium one-piece molding, installation hole size $\Phi 25/\Phi 35/\Phi 45$ small and lightweight, can be used for combination lighting, display cabinet lighting, etc., small body big role.

Compact and easy to install, the fixtures are available in bezel-less and narrow bezel options, which not only fit snugly into the ceiling without any abruptness, but also keep the ceiling simple and adaptable to any style.





Conceal series, with its compact size and fine design has a minimum opening diameter of only 25mm, which meets the strict requirements for size in narrow spaces.



Precise beam angles of 15°/24°/36° with different effect spots.



Multiple color options

The lamp body offers classic black and white colour options, enhancing personalised decoration and flexibility to adapt to different scenarios making it easy to coordinate with a variety of interior styles.



Model	Power	Beam Angle	CRI	CCT	Cut-out(mm)	Size(mm)
BM-YSI025	5W	15°/24°/36°	>97	2700K/3000K/3500K/4000K	Φ25	Φ30x72
BM-YSI035	7W	15°/24°/36°	>97	2700K/3000K/3500K/4000K	Φ35	Φ40x77
BM-YSI045	9W	15°/24°/36°	>97	2700K/3000K/3500K/4000K	Φ45	Φ50x82



Model	Power	Beam Angle	CRI	CCT	Cut-out(mm)	Size(mm)
BM-YSI025W	5W	15°/24°/36°	>97	2700K/3000K/3500K/4000K	Φ35	Φ60x72
BM-YSI035W	7W	15°/24°/36°	>97	2700K/3000K/3500K/4000K	Φ45	Φ70x77
BM-YSI045W	9W	15°/24°/36°	>97	2700K/3000K/3500K/4000K	Φ55	Φ80x82

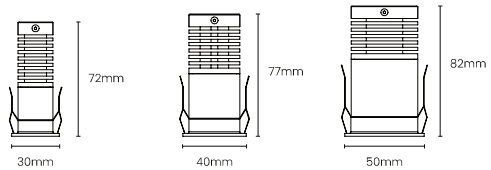

BM-YSI025 BM-YSI035 BM-YSI045

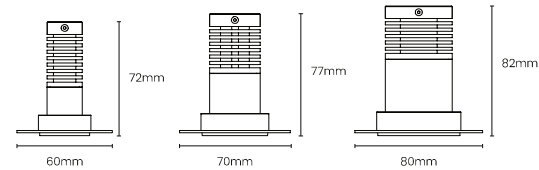

BM-YSI025W BM-YSI035W BM-YSI045W

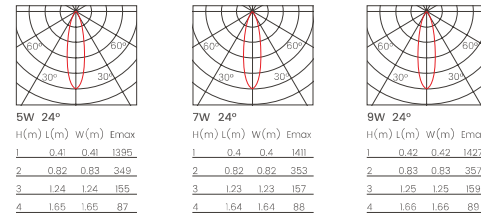
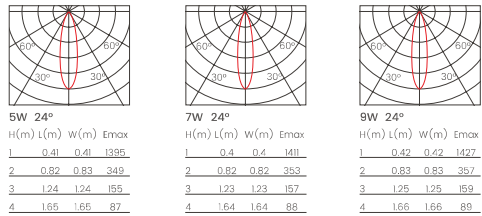

Optional Accessories



Honeycomb Combed Glass Soft Glass

Optional Accessories



Honeycomb Combed Glass Soft Glass



 GRAZER

The lamps provide a variety of installation methods with precise wall lighting, creating rich light and shadow, strengthening the cultural atmosphere of the space, suitable for hotels, clubs, high-end real estate and commercial space.

Installation Effect

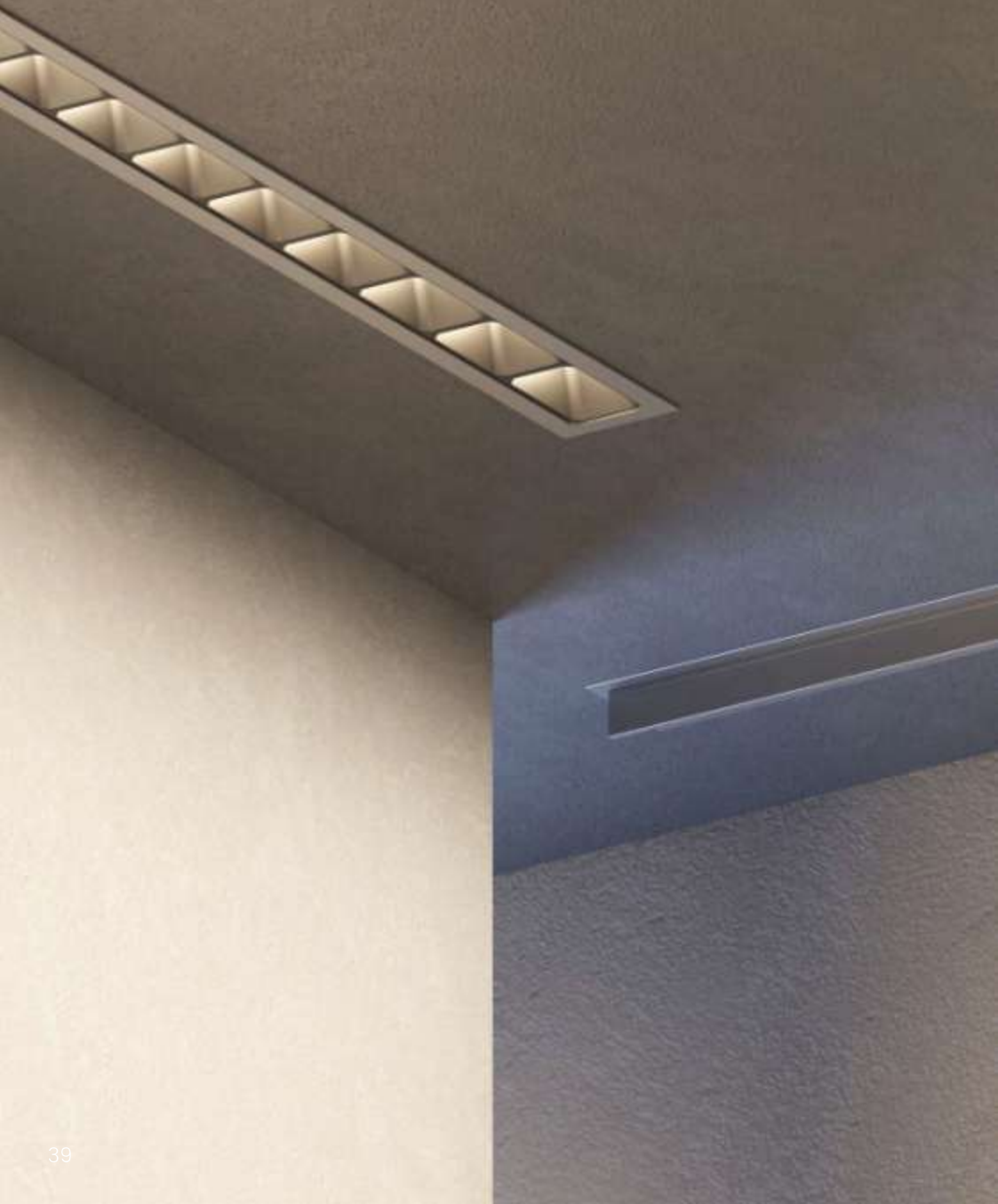

Honeycomb Anti-Glare

MORE POSSIBILITIES

Featuring flexible angle adjustment, this luminaire is able to change the direction of the light beam freely, providing a versatile and flexible lighting solution for spacious spaces.

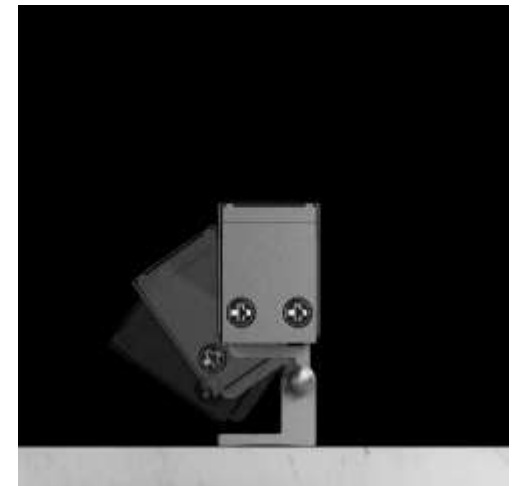

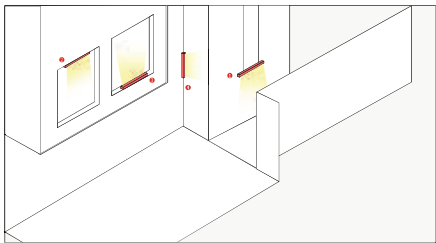

- 1 Suspension
- 2 Surface
- 3 Aluminum Side Pass
- 4 Wall Mounted

Installation

A wide range of installation combinations are available to ensure optimum performance of light in the space, creating colourful light and shadow effects and enhancing the overall sense of spatial ambience.

Product Information

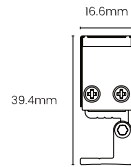

Model	Power	Beam Angle	CRI	CCT	Flux	Size(mm)
BM-XX11621M-25	24W	25°/40°/60°/30°x65°	>90	2700K/3000K/4000K	1900lm/m	16.6x39.4x249.4
BM-XX11621M-50	24W	25°/40°/60°/30°x65°	>90	2700K/3000K/4000K	1900lm/m	16.6x39.4x499.6
BM-XX11621M-100	24W	25°/40°/60°/30°x65°	>90	2700K/3000K/4000K	1900lm/m	16.6x39.4x1000

Colour

- Matte black
- Matte white

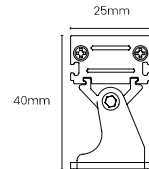

Model	Power	Beam Angle	CRI	CCT	Flux	Size(mm)
BM-XX12515M-25	24W	20°/30°/45°/60°/25°x45°	>90	2700K/3000K/4000K	1900lm/m	25x40x252
BM-XX12515M-50	24W	20°/30°/45°/60°/25°x45°	>90	2700K/3000K/4000K	1900lm/m	25x40x502
BM-XX12515M-100	24W	20°/30°/45°/60°/25°x45°	>90	2700K/3000K/4000K	1900lm/m	25x40x1000

Colour

- Matte black
- Matte white
- Silver anodised

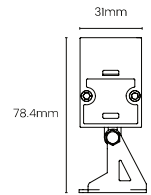

Model	Power	Beam Angle	CRI	CCT	Flux	Size(mm)
BM-XX13145M-25	24W/48W	24°/30°/40°/60°/30°x60°	>90	2700K/3000K/4000K	1700(3200)lm/m	3lx78.4x251.2
BM-XX13145M-50	24W/48W	24°/30°/40°/60°/30°x60°	>90	2700K/3000K/4000K	1700(3200)lm/m	3lx78.4x496.2
BM-XX13145M-100	24W/48W	24°/30°/40°/60°/30°x60°	>90	2700K/3000K/4000K	1700(3200)lm/m	3lx78.4x992.5

Colour

- Matte black
- Matte white

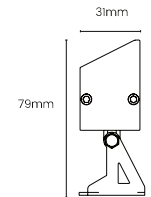

Model	Power	Beam Angle	CRI	CCT	Flux	Size(mm)
BM-XX13146M-25	24W/48W	24°/30°/40°/60°/30°x60°	>90	2700K/3000K/4000K	1700(3200)lm/m	3lx79x251.2
BM-XX13146M-50	24W/48W	24°/30°/40°/60°/30°x60°	>90	2700K/3000K/4000K	1700(3200)lm/m	3lx79x496.2
BM-XX13146M-100	24W/48W	24°/30°/40°/60°/30°x60°	>90	2700K/3000K/4000K	1700(3200)lm/m	3lx79x992.5

Colour

- Matte black
- Matte white

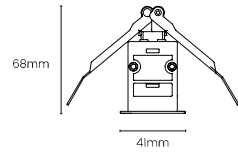

Model	Power	Beam Angle	CRI	CCT	Flux	Size(mm)
BM-XXI4145Q-25	24W/48W	24°/30°/40°/60°/30°x60°	≥90	2700K/3000K/4000K	1700(3200)LM/m	4x68x261.2
BM-XXI4145Q-50	24W/48W	24°/30°/40°/60°/30°x60°	≥90	2700K/3000K/4000K	1700(3200)LM/m	4x68x506.2
BM-XXI4145Q-100	24W/48W	24°/30°/40°/60°/30°x60°	≥90	2700K/3000K/4000K	1700(3200)LM/m	4x68x1002.5

Colour

- Matte black
- Matte white

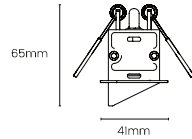

Model	Power	Beam Angle	CRI	CCT	Flux	Size(mm)
BM-XXI4146Q-25	24W/48W	24°/30°/40°/60°/30°x60°	≥90	2700K/3000K/4000K	1700(3200)LM/m	4x65x261.2
BM-XXI4146Q-50	24W/48W	24°/30°/40°/60°/30°x60°	≥90	2700K/3000K/4000K	1700(3200)LM/m	4x65x506.2
BM-XXI4146Q-100	24W/48W	24°/30°/40°/60°/30°x60°	≥90	2700K/3000K/4000K	1700(3200)LM/m	4x65x1002.5

Colour

- Matte black
- Matte white

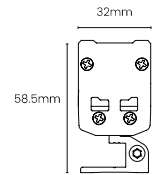

Model	Power	Beam Angle	CRI	CCT	Flux	Size(mm)
BM-XXI3242M-25	24W/48W	24°/30°/40°/60°/30°x60°	≥90	2700K/3000K/4000K	1700(3200)LM/m	32x58.5x249.2
BM-XXI3242M-50	24W/48W	24°/30°/40°/60°/30°x60°	≥90	2700K/3000K/4000K	1700(3200)LM/m	32x58.5x494.4
BM-XXI3242M-100	24W/48W	24°/30°/40°/60°/30°x60°	≥90	2700K/3000K/4000K	1700(3200)LM/m	32x58.5x990.5

Colour

- Matte black
- Matte white

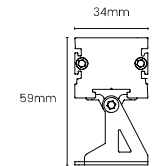

Model	Power	Beam Angle	CRI	CCT	Flux	Size(mm)
BM-XXI3242M-30	24W/48W	24°/30°/40°/60°/30°x60°	≥90	2700K/3000K/4000K	1700(3200)LM/m	34x59x300
BM-XXI3242M-50	24W/48W	24°/30°/40°/60°/30°x60°	≥90	2700K/3000K/4000K	1700(3200)LM/m	34x59x500
BM-XXI3242M-100	24W/48W	24°/30°/40°/60°/30°x60°	≥90	2700K/3000K/4000K	1700(3200)LM/m	34x59x1000

Colour

- Matte black
- Matte white

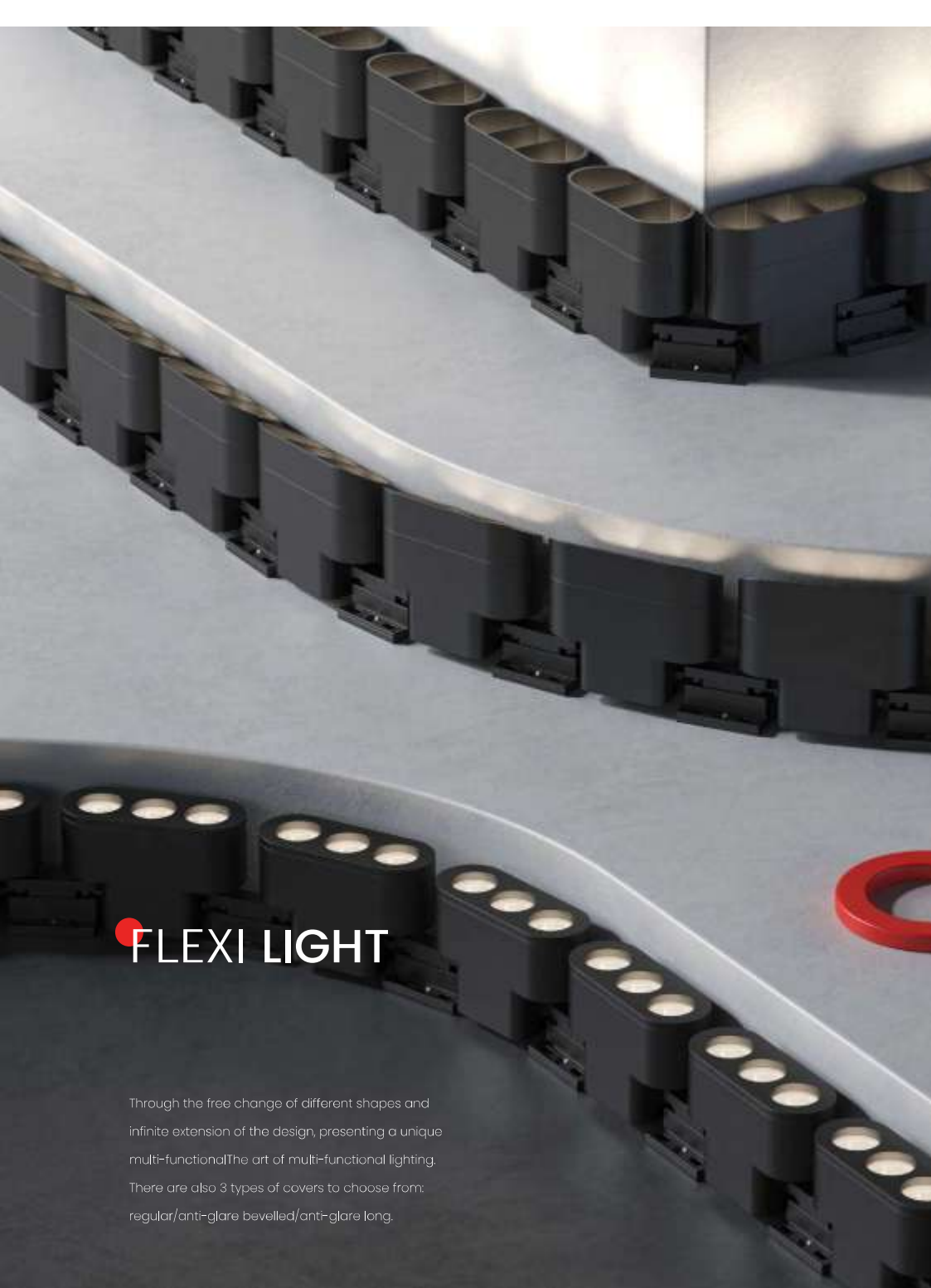

FLEXI LIGHT

Through the free change of different shapes and infinite extension of the design, presenting a unique multi-functional lighting. There are also 3 types of covers to choose from: regular/anti-glare bevelled/anti-glare long.



Switching the Shapes Flexibly.



S-shape



Round



Right Corner



Product Information



Model	Voltage	Power	Beam Angle	CRI	CCT	Cut-out(mm)	Size(mm)
BM-LTI3265	24VAC	3x5W	8°/15°	>90	2700K/3000K/ 4000K	/	(110x43)xW33xH57.5

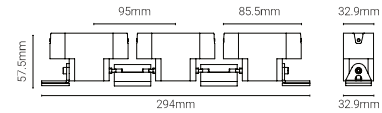

BM-LTI3265

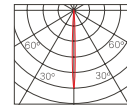

3x5W 8°			
H(m)	L(m)	W(m)	E(max)
1	0.15	0.15	618
2	0.3	0.3	155
3	0.4	0.4	69
4	0.55	0.55	39

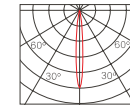

3x5W 15°			
H(m)	L(m)	W(m)	E(max)
1	0.3	0.3	1235
2	0.6	0.6	309
3	0.8	0.8	137
4	1.1	1.1	77

Optional Accessories



Regular



Anti-glare long tube



Anti-glare bevelled

Lumensense «

Born in the UAE

Lumensense Lighting - PO Box 940449 - Dubai - United Arab Emirates

Contact Litepros for more details:

UAE: Design Villa 9A, Street 2A, Jumeirah 1, PO Box 940449, Dubai, United Arab Emirates

Email: garry@litepros.co

UK: Unit 4b, Bradley Park, High Holborn Road, Ripley, Derbyshire, DE5 3NW, United Kingdom

Email: litemeup@lumensense.co

